

门禁专用电源接线图

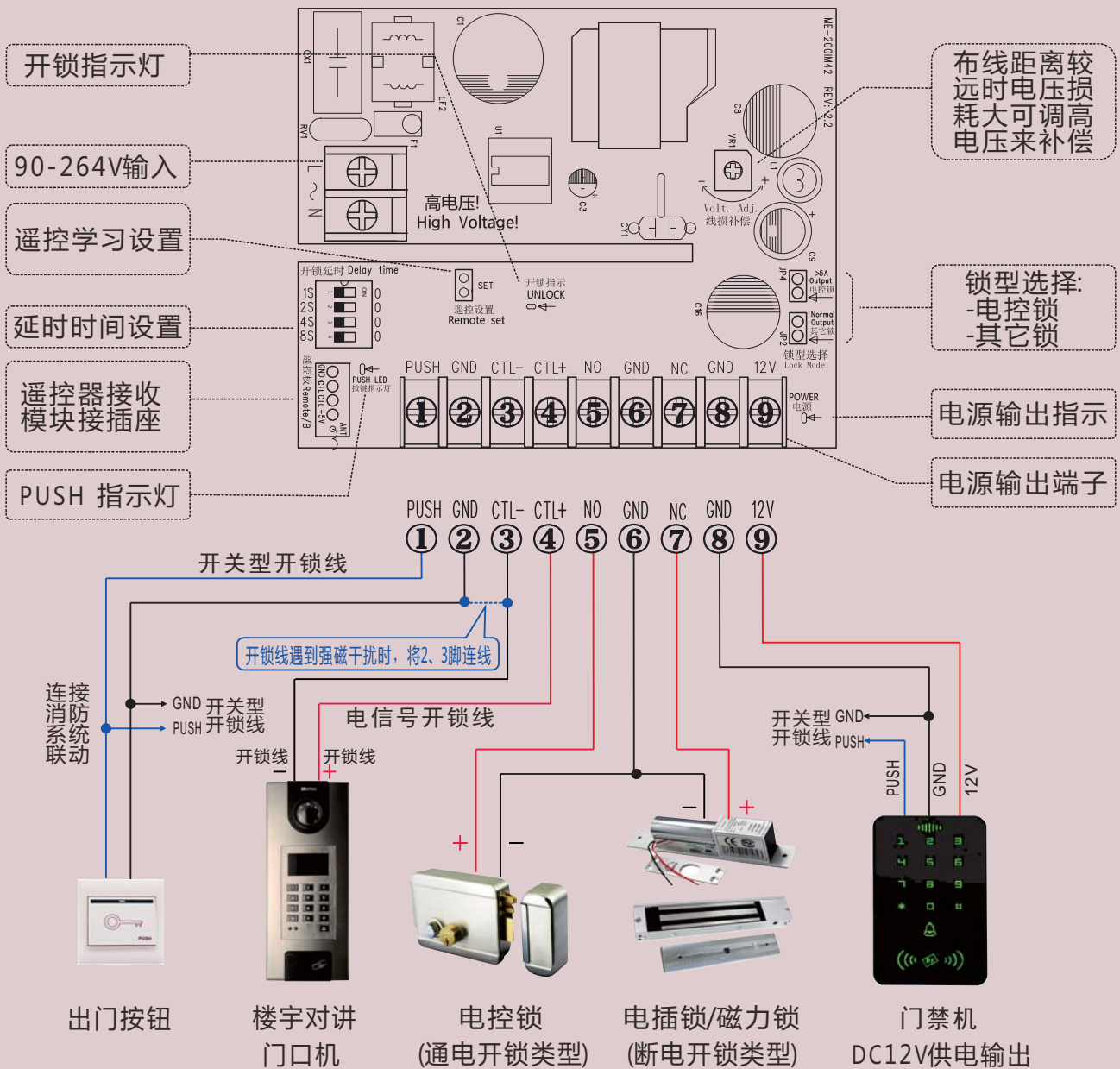

【接线注意】 箱内有高压，请断电后再安装和检修，谨防触电！

门禁专用电源接线图

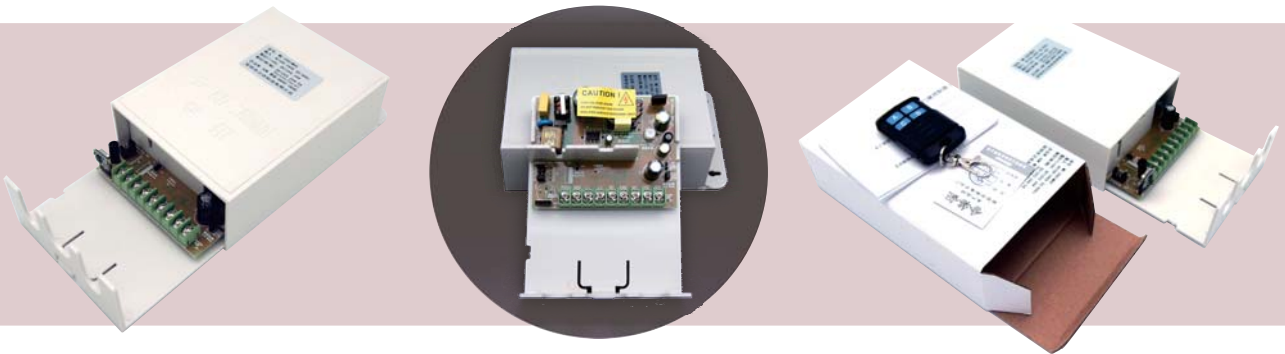
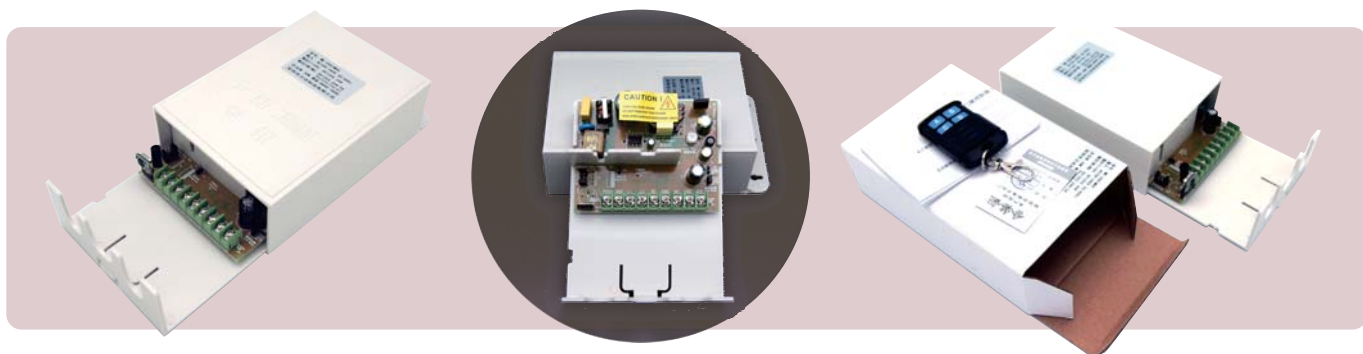

交流输入

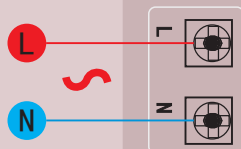

门禁专用电源

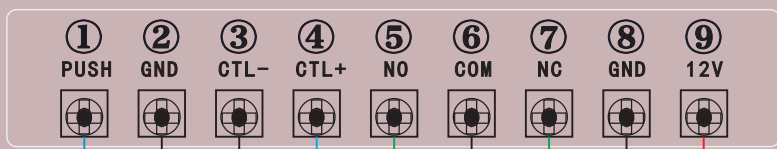

出门按钮



消防联动常开触点

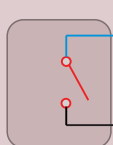

有源开锁信号

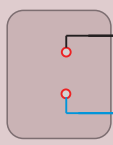

(DC3-30V)

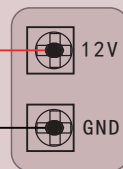

12V 供电输出

(电控锁)

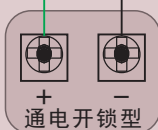

通电开锁型

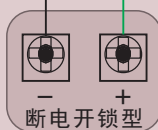

(磁力锁)



Wiring diagram of power supply control box

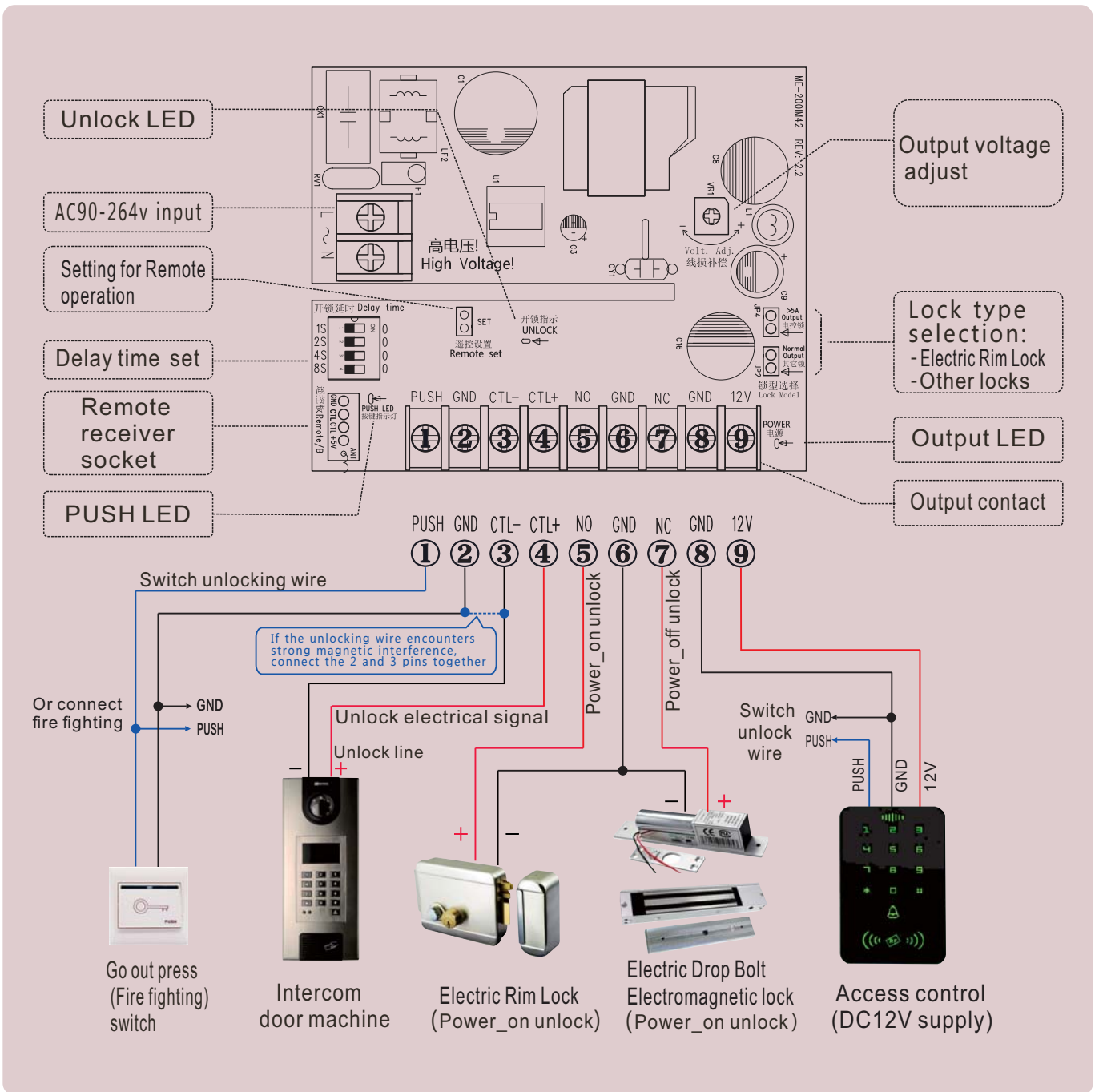
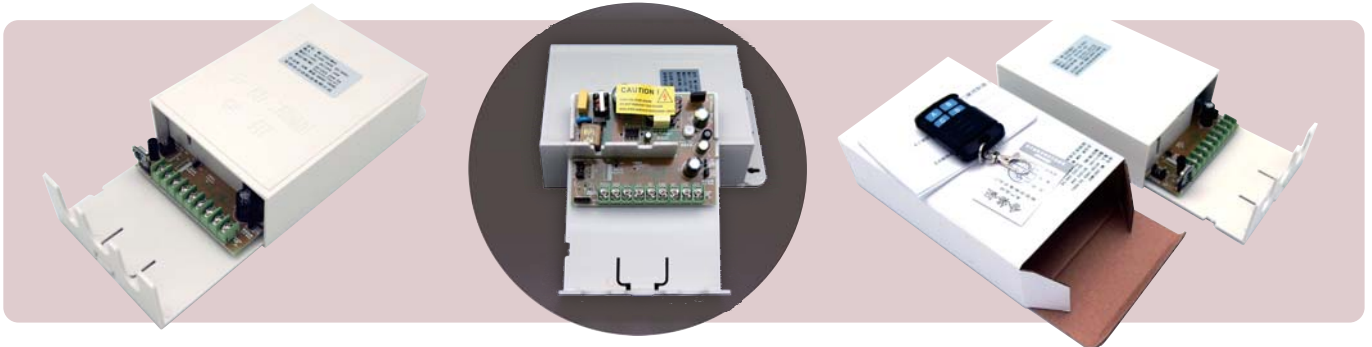

【Wiring instruction】 High voltage inside, danger! Please power off when install, wiring and Repair inspection.

Wiring diagram of power supply control box

